

On opaque agreement relations in German A-N-N compounds

Katja Barnickel*

Abstract

A(djective)-N(oun)-N(oun) compounds in German exhibit unexpected internal inflection with respect to case and number. On the surface it seems as if compound internal agreement would violate Earliness and locality conditions. The aim of this paper is to shed some light on the question what kind of opaque processes take place in German A-N-N compounds. I briefly discuss an analysis of A-N-N compounds that has been proposed for Dutch. First, I will show that this analysis alone, which involves feature-sharing, cannot account for German A-N-N compounds. Secondly, I will propose an alternative analysis which produces the correct empirical results for German. This alternative crucially relies on the order of the elementary operations Merge and Agree and the bias for Spec-Head-Agree in order to resolve the agreement opacity.

1. Introduction

1.1. The phenomenon

A(djective)-N(oun)-N(oun) compounds are compounds that consist of two parts: a noun N_1 which is modified by an adjective A and a second noun N_2 which is modified by $[_{NP} A N_1]$. (1) illustrates documented cases of the productive pattern in German.

- (1) Documented A-N-N compounds (taken from Lawrenz 1995: 39)
- a. das Verdrängte-Aggressionen-Syndrom
the suppressed-aggression-syndrome
'the suppressed aggression syndrome'

*For very helpful advice, comments and discussion I would like to thank Martin Salzmann, Doreen Georgi and Timo Klein. Furthermore, thanks to Andrew Murphy for the English translations of the German A-N-N compounds and thanks to all who participated in my written or oral grammaticality judgement survey.

- b. der Graue-Schläfen-Effekt
the gray-temples-effect
'the gray (hair on the) temples effect'
- c. das Heile-Bergwelt-Image
the idyllic-mountain.landscape-image
'the imagine of unspoilt mountains'
- d. die Brave-Kind-Haltung
the honest-child-attitude
'the behaving like a good child'
- e. Obere-Mittelklasse-Wagen
upper-middle.sized.class-car
'upper mid-range car'
- f. Höhere-Töchter-Manieren
higher-daughters-manners
'lady-like manners'
- g. Kleine-Leute-Viertel
little-people-neighborhood
'the district for ordinary people'
- h. die Starke-Mann-Manier
the strong-man-manner
'the tough man act'
- i. ein Alte-Herren-Verein
an old-men-club
'a gentleman's club'
- j. das Graue-Maus-Dasein
the gray-mouse-existence
'the plain Jane existence'

In the following subsection I will show that A-N-N compounds exhibit unexpected internal inflection, which is interesting from a morphological as well as from a syntactic perspective.

1.2. Opaque agreement

In the German DP the determiner and the attributive adjective agree with the following noun in case, number and gender. In (2) case is assigned by the preposition.

- (2) wegen d-es brav-en Mädchen-s
 because.of the-N.SG.GEN good-N.SG.GEN girl-N.SG.GEN
 'because of the good girl'

There seem to be two groups of A-N-N compounds. In the first group the head noun N_2 agrees in case, gender and number with the determiner. The adjective and N_1 are marked with default, i.e. they bear nominative case, independent of N_2 's inflection. In (3), (4) and (5) A- N_1 cases with regular agreement of A and N_1 (a-examples) are contrasted with the A- N_1 - N_2 cases where A does not agree with N_2 (b-examples).

- (3) a. bei d-er Erst-en Hilfe
 at the-F.SG.DAT first-F.SG.DAT aid.F.SG.DAT
 'during first aid'
 b. bei d-er Erst-e Hilfe Ausbildung
 at the-F.SG.DAT first-F.SG.NOM aid.F.SG.NOM education.F.SG.DAT
 'during first aid training'¹
- (4) a. vor d-er Dritt-en Welt
 before the-M.SG.DAT third-F.SG.DAT world.F.SG.DAT
 'before the Third World'
 b. vor d-em Dritt-e Welt
 in.front.of the-M.SG.DAT third-F.SG.NOM world.F.SG.NOM
 Laden
 store.M.SG.DAT
 'in front of the Third World Shop'
- (5) a. an d-em schön-en Wochenende
 at the-N.SG.DAT nice-N.SG.DAT weekend.N.SG.DAT
 'at the nice weekend'
 b. mit d-em Schön-es Wochenende
 with the-N.SG.DAT nice-N.SG.NOM weekend.N.SG.NOM
 Ticket
 ticket.N.SG.DAT
 'with the Nice-Weekend-Ticket'

¹In order to avoid confusion with bound morphemes, hyphens between the German A, N_1 and N_2 are omitted in all upcoming glossed examples.

In the second group it seems as if the adjective and N_1 agree in case, gender and number as well, together with the head noun N_2 .²

- (6) a. ohne sein-en Gut-en Morgen
without his-M.SG.ACC good-M.SG.ACC morning-M.SG.ACC
Tee
tea.M.SG.ACC
'without his good morning tea'
- b. mit ihr-em Brav-en Mädchen Image
with her-N.SG.DAT good-N.SG.DAT girl.N.SG.DAT image-N.SG.DAT
'with her good girl image'
- c. neben d-er Rot-en Kreuz Schwester
beside the-F.SG.DAT red-F.SG.DAT cross.N.SG.DAT nurse.F.SG.DAT
'next to the Red Cross nurse'

However, as observed by Lawrenz (1995) there is neither case nor number agreement between the adjective and N_1 . This becomes obvious when the preposition assigns genitive case. If there was case agreement between the adjective, N_1 and N_2 , as illustrated in (6), N_1 would show the appropriate genitive-marker *-(e)s*. The examples in (7) show that this is not the case.

- (7) a. wegen sein-es Gut-en Morgen(*s)
because.of his-M.SG.GEN good-M.SG.GEN morning-M.SG.NOM
Tee-s
tea.M.SG-GEN
'because of his good morning tea'

²Nominative inflection seems to be possible as well (informal judgments vary):

- (i) a. ohne sein-en Gut-e Morgen Tee
without his-M.SG.ACC good-M.SG.NOM morning-M.SG.NOM tea.M.SG.ACC
'without his good morning tea'
- b. mit ihr-em Brav-e Mädchen Image
with her-N.SG.DAT good-N.SG.NOM girl.N.SG.NOM image-N.SG.DAT
'with her good girl image'
- c. ?neben d-er Rot-e Kreuz Schwester
beside the-F.SG.DAT red-F.SG.NOM cross.N.SG.NOM nurse.F.SG.DAT
'next to the Red Cross nurse'

- b. aufgrund ihr-es Brav-en Mädchen(*s)
 because.of her-N.SG.GEN good-N.SG.GEN girl.N.SG.NOM
 Image-s
 image-N.SG.GEN
 'because of her good girl image'
- c. wegen d-er Rot-en Kreuz(*es)
 because.of the-F.SG.GEN red-F.SG.GEN CROSS.N.SG.NOM
 Schwester
 nurse.F.SG.GEN
 'because of the Red Cross nurse'

Further evidence that A and N₁ do not agree comes from number agreement (Lawrenz 1995). If A agrees with N₁, one would expect that if N₁ is specified for plural, A is specified for plural as well. This is not the case. (8) and (9) show that A rather agrees in number with N₂.³

- (8) a. die Schön-e Ding-e Boutique
 the nice-SG thing-PL boutique.SG
 'the boutique of nice things'
- b. *die Schön-en Ding-e Boutique
 the nice-PL thing-PL boutique.SG
 'the boutique of nice things'

³One could guess that the *-e* in *schön-e* and *kurz-e* is not the weak inflection singular marker (*die schön-e Boutique* 'the nice boutique'), but the marker for the nominative strong inflection which appears e.g. if there is no determiner (*Ø schön-e Boutique* 'nice boutique'). That this is not the case can be seen in the singular A-N-N examples, where strong inflection on the adjective is never grammatical (beside in proper names like *Schön-es-Wochenende-Ticket* 'Nice-Weekend-Ticket'):

(i) *Adjectives with strong inflection*

- a. *d-er [Gut-er Morgen] Tee
 the-M.SG.NOM good-M.SG.NOM morning-M.SG.NOM tea.M.SG.NOM
 'the good morning tea'
- b. *d-as [Brav-es Mädchen] Image
 the-N.SG.NOM good-N.SG.NOM girl.N.SG.NOM image-N.SG.NOM
 'the good girl image'
- c. *d-ie [Brav-es Kind] Haltung
 the-F.SG.NOM good-N.SG.NOM child.N.SG.NOM attitude.F.SG.NOM
 'the behaving like a good child'

- (9) a. das Kurz-e Hose-n Wetter
 the short-SG trousers-PL weather.SG
 ‘the shorts weather’
- b. *das Kurz-en Hose-n Wetter
 the short-PL trousers-PL weather.SG
 ‘the shorts weather’

Agreement in A-N-N compounds can be summarized as follows:

- (10) *Agreement in A-N-N compounds*
- a. The adjective and N₁ are default case-marked (nominative), N₂ receives case from an external head.
- b. The adjective agrees with N₂ in case and number; N₁ bears the unmarked case (nominative) (vgl. (7)).

For the scenario in (10a), where adjective and N₁ both are nominative marked, I assume the following structure.

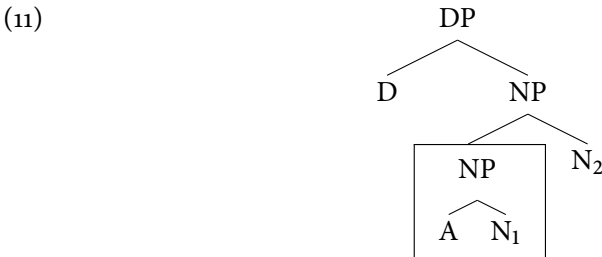

In (11) the adjective is part of an A-N compound (framed) which is built in the lexicon before it enters the syntactic derivation. Evidence for this assumption comes from the observation that A-N components that do not agree with N₂ seem to be strongly lexicalized (*Dritte Welt* ‘Third World’, *Erste Hilfe* ‘first aid’, *schönes Wochenende* ‘nice weekend’, *gute Nacht* ‘good night’) or even idiomatic ones (*graue Maus* ‘grey mouse’ = *mousy person*).⁴

⁴The finding that adjectives which are part of a lexicalized expression rather do not show any agreement is based on an informal survey with German native speakers. The survey indeed showed that this is only a tendency. An example which violates the generalization that adjectives in lexicalized expression do not show agreement, e.g. is *wegen der Roten-Kreuz-Schwester* ‘because of the Red Cross nurse’. In some cases the judgments strongly vary: As many participants preferred *mit ihrer Heile-Welt-Stimmung* as *mit ihrer Heilen-Welt-Stimmung* ‘with her perfect world feeling’.

A further option to account for the default case-marking on A and N₁ is early spell-out of the [A-N₁]-component (De Belder and van Koppen 2013, see section 2.1 of this paper for details). This means that speakers send the [A-N₁]-component to PF as soon as it is merged. In this paper I will leave aside all cases which include strongly lexicalized or idiomatic expressions that are built in the lexicon or are sent to spell-out immediately. Instead, I will focus on the group of A-N-N compounds in (10b). In these cases it is not plausible to assume that A and N₁ enter the syntactic derivation as a fixed idiomatic expression or that they are spelled out early, since the adjective interacts with N₂. These cases are interesting because this interaction is opaque.

(12) *Opaque agreement*

The adjective agrees with N₂ in case and number; N₁ bears the unmarked case (nominative).

Concerning the structure of these cases, they seem to be an instance of a bracketing paradox: semantically the adjective specifies N₁ (13). Syntactically, however, it seems to be related to N₂ (14).

(13) Semantic structure

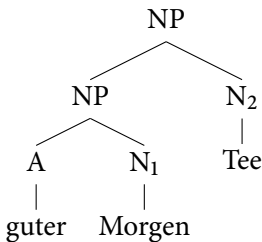

(14) Syntactic structure

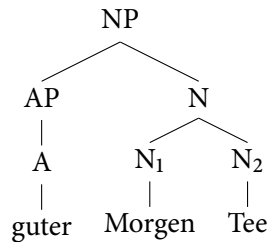

The structure in (13) has to be the underlying one to yield the correct semantic interpretation. Given the generalization in (10b), repeated as (12) above, the following two questions arise:

1. Why does the adjective not agree with N₁?

According to the Earliness requirement (Pesetsky 1989), which demands that operations apply as soon as their context is met, Agree- and Merge-inducing features must be discharged as soon as possible. In the case of A-N-N compounds it seems like as if this requirement is vio-

lated: as soon as A and N_1 are merged, one would expect A to agree with N_1 immediately.

2. What does the adjective rather force to agree with N_2 ?

Agreement of A and N_2 seems to violate the condition on locality: if there is any interaction of A with one of the N's, under the assumption of bottom-up structure building one would expect A to agree with the closer N_1 .

The aim of this paper is to shed some light on the question what kind of opaque processes take place in German A-N-N compounds which on the surface seem to violate Earliness and locality conditions. The paper is organized as follows: First, I will briefly introduce the analysis of A-N-N compounds proposed by De Belder and van Koppen (2013) for Dutch. I will show that this analysis, which involves feature-sharing, cannot account for the agreement facts in German A-N-N compounds alone. After the illustration and discussion of the problems with this analysis, I will present an alternative proposal which provides the correct empirical results for German. This alternative also includes feature-sharing, but the crucial point is that it makes use of the order of the elementary operations Merge and Agree and the bias for Spec-Head-Agree.

2. Analysis

2.1. Analyzing Dutch A-N-N compounds (De Belder and van Koppen 2013)

De Belder and van Koppen (2013) report on internal inflection in Dutch A-N-N compounds.

- (15) kaal-e-kat-adoptie
 hairless-AGR-cat-adoption
 'adoption of hairless cats'

Adjectives in the Dutch DP are marked for definiteness.

- (16) *Adjective inflection in the Dutch DP*
 /Ø/ → [neuter, singular, indefinite]
 /-e/ → elsewhere

Definiteness is encoded on D. The [A-N₁]-constituent lacks the definiteness information, since it lacks its own D-layer.

- (17) *een de-kaal-e-kat-adoptie
 a the-hairless-AGR-cat-adoption

If the [A-N₁]-constituent lacks its own D-layer which contains the definiteness information, how can the unvalued definiteness feature [udef] on the adjective get valued? De Belder and van Koppen (2013) mention two possible strategies:

- (18) a. Strategy 1:
 The [udef]-feature on the adjective does not get valued and a default spell out obtains (Preminger 2011), resulting in the elsewhere affix *-e* on the adjective.
- b. Strategy 2:
 Adjectival inflection inside the [A-N₁]-constituent is sensitive to functional material belonging to the D-head of the compound. The [udef]-feature on the adjective gets valued by the [idef]-feature of the D-head of the entire compound. In the context of the feature specification [neuter, singular, indefinite] this would lead to the marker \emptyset .

A huge online survey (nearly 700 participants) showed that both strategies occur. The elsewhere affix *-e* is always an option. De Belder and van Koppen (2013) account for this observation assuming that spell-out obtains before [A-N₁] is merged with N₂. The *e*-affix realizes a defective feature set, namely a set that contains an unvalued feature.

The second observation was a preference for the \emptyset -marker on the adjective in the context of indefinite A-N_{neut}-N compounds.⁵ The \emptyset -marker is only available for the feature specification [neuter, singular, indefinite]. De Belder and van Koppen (2013) conclude from this finding that the [udef]-feature of the adjective gets valued from the [idef]-feature on the D-head of the entire compound. Technically, this is done via feature-sharing.

⁵This marker is neither preferred in the case of definiteness nor for compounds where N₁ is different from neuter.

In the following section I will briefly introduce the idea of feature-sharing (Frampton and Gutman 2006, Pesetsky and Torrego 2007). Subsequently, I will show that a feature-sharing analysis as proposed for Dutch A-N-N compounds poses serious problems for German A-N-N compounds. This is due to the fact that German has case-agreement which Dutch lacks.

2.2. Feature-sharing in German A-N-N compounds

I will make the following assumptions: All syntactic operations are feature-driven. The two basic operations are *Merge* for structure building and *Agree* for argument encoding by case assignment/agreement. These are triggered by the following features (Heck and Müller 2007).

- (19) *Two types of features that drive operations*
- a. Structure building features (e.g. subcategorization features) [$\bullet F \bullet$] trigger Merge with an element that bears a corresponding feature [F].
 - b. Probe features [$*F*$] trigger Agree.

I adopt the following definition of Agree (Chomsky 2000, 2001).

- (20) Agree between a probe P and a goal G obtains if the following conditions are met:
- a. A probe P c-commands a goal G.
 - b. G is the closest goal to P (e.g. there is no other goal H which asymmetrically c-commands G).
 - c. G is active (G has an unvalued case feature).
 - d. P bears at least one unvalued probe feature and thereby seeks the value of a matching feature of G
... with the result that ...
 - e. G values P (ϕ -features) and P values G (case).

I take Agree to be feature-sharing (Frampton and Gutman 2006, Pesetsky and Torrego 2007). This means if G does not provide a value for G, P and G share the unvalued feature. This feature is valued on P and G later in the derivation by a probe P' which is specified for a value (for DP internal feature-sharing see also Georgi and Salzmann 2010).

Further I assume that probe features (noted as [$*F:v*$] (=valued) or [$*F:\square*$])

(=unvalued)) as well as subcategorization (Merge-inducing) features must be checked immediately (*Earliness requirement*).

To ensure that the correct semantic interpretation is available, I assume that the basic structure is the one in (21).

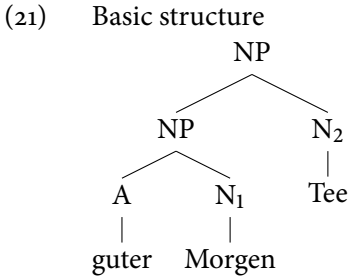

In the following the derivation is shown step by step:

1. A and N₁ are merged (attributive adjectives are adjuncts, see Svenonius 1994, Schoorlemmer 2009). N₁ bears an unvalued case feature and inherent ϕ -features. A is completely unvalued for case and ϕ -features.

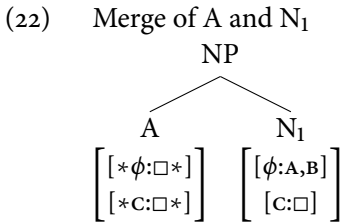

2. Given the Earliness requirement, A and N enter an Agree relation as soon as they are merged. Since N₁ has no valued case feature yet, it cannot value the case-probe on A. Instead, A and N₁ share the unvalued case feature. After ϕ -Agree A and N₁ share the valued ϕ -features of N₁.⁶

⁶Shared unvalued features are noted with α , discharged features are underlined. For the sake of convenience, in all graphic illustrations ϕ -features are located on the probe after Agree with the goal which provides these features. Nevertheless, it should be kept in mind that in fact ϕ -probes are not valued in a traditional sense after Agree, but that they *share* the valued features with their goal. The same illustration holds for case features: in fact not every element bears its own case feature, rather there is only *one* which is shared.

(23) Agree of A and N₁

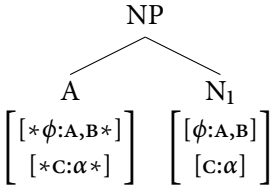

3. The next step is Merge of N₂ (adjunction). N₂ bears inherent φ-features and an unvalued case feature.

(24) Merge of N₂

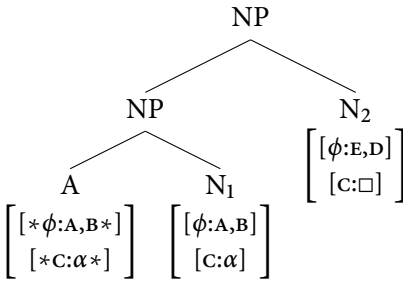

4. N₂ and A enter an Agree relation. Since neither A nor N₂ have a valued case feature yet, no case valuation takes place. Rather, N₂ now shares the unvalued case feature (α) with A which additionally is already shared with N₁. N₂ bears inherent φ-features, but since at this point of the derivation there is no unvalued φ-probe in the structure, no φ-Agree takes place.

(25) Agree of A with N₂

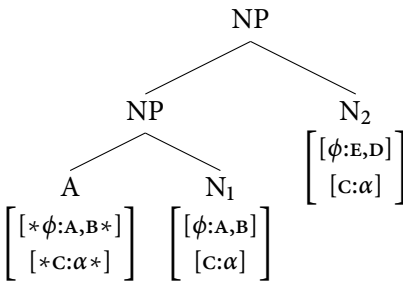

5. D is merged (D selects the NP). D bears an unvalued case-probe as well

(27) Merge and Agree of v

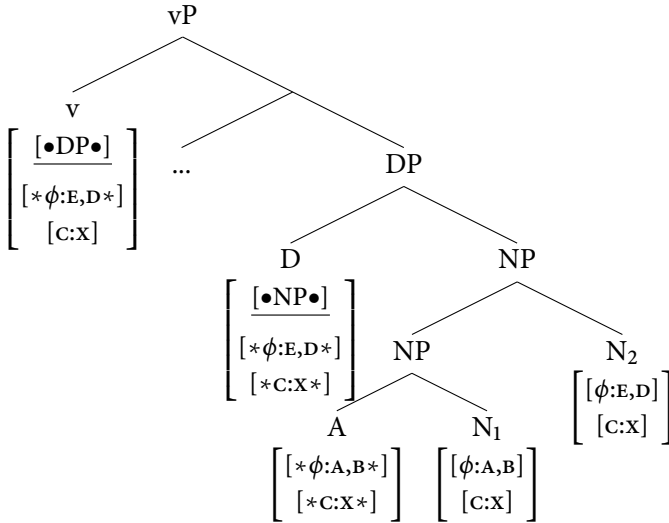

The step-by-step derivation illustrates that feature-sharing as proposed for Dutch is not an option to analyze German A-N-N compounds. D, A, N₁ and N₂ all get the same case feature, because they all share it. This is not the right result for German. If e.g. P is the case assigner and if P assigns genitive, one can see that this leads to the wrong prediction that D, A, N₁ and N₂ all bear genitive case (see (28)). For Dutch this is not a problem because Dutch lacks case-Agree (no case marking).

- (28) a. wegen sein-es Gut-en Morgen(*s)
 because.of his-M.SG.GEN good-M.SG.GEN morning-M.SG.NOM
 Tee-s
 tea.M.SG-GEN
 'because of his good morning tea'
- b. aufgrund ihr-es Brav-en Mädchen(*s)
 because.of her-N.SG.GEN good-N.SG.GEN girl.N.SG.NOM
 Image-s
 image-N.SG-GEN
 'because of her good girl image'

- c. wegen d-er Rot-en Kreuz(*es)
 because.of the-F.SG.GEN red-F.SG.GEN CROSS.N.SG.NOM
 Schwester
 nurse.F.SG.GEN
 ‘because of the Red Cross nurse’

Concerning number, this analysis yields the wrong result as well. If A agreed with N_1 , one would expect that if N_1 is specified for plural, A is specified for plural as well. This is not the case. (29) shows that A rather agrees in number with N_2 .⁷

- (29) a. die Schön-e Ding-e Boutique
 the nice-SG thing-PL boutique.SG
 ‘the boutique of nice things’
 b. *die Schön-en Ding-e Boutique
 the nice-PL thing-PL boutique.SG
 ‘the boutique of nice things’

What could be a possible solution to the problem that the sketched feature-sharing analysis does not predict the correct results for case and number agreement? One possibility to prohibit agreement of A and N_1 would be to assume that N_1 is already sent to spell-out before it enters an Agree relation with A. One would have to assume that APs are phases, and that after completion of the phase by merging the complement, the complement is spelled out immediately and hence not accessible anymore. This way early spell-out of N_1 would lead to the consequence that N_1 does not participate in any feature-sharing process with A, N_2 and D. Whereas A, N_2 and D would receive the same case because of their shared features, N_1 would be spelled out with the default nominative case.

Under this assumption the right empirical predictions are derived (N_1 is always default case-marked, A agrees in number with N_2 rather with N_1). The problem which arises is that ‘regular’ DPs (including an AP, but only one N)

⁷Instead of feature-sharing one could assume that case is assigned via *Multiple Agree* (Hiraiwa 2001, Vainikka and Brattico 2014). That means that the case of a functional head can be assigned to more than one element (e.g. to D and N heads or other DP internal elements that inflect for case, see e.g. Assmann et al. 2014). However, under this alternative the problem would remain the same: since those elements that have an unvalued case feature receive a value, D, A, N_1 and N_2 would all get the same case from a v- or a P-head.

cannot be analyzed this way. The assumption that complements of a phase (or at least AP-phases) are always spelled out early makes the wrong prediction that Agree between A and N_1 could never happen.

2.3. Feature-sharing revisited: a structural alternative

Under the alternative proposal I want to put forward in this section, the underlying structure of an A-N-N compound is slightly different. For the analysis, I make the following assumptions in addition to those made above about Merge and Agree.

- (i) Adjectives are functional heads that select their complements (NPs, DPs, APs), see Abney (1987).
- (ii) Agree takes place under m-command (Agree may affect a head and its specifier). In case a head can agree with its complement *or* with its specifier, Spec-head Agree is preferred (Chomsky 1986, 1995, Koopmann 2006, Assmann et al. 2012; for a similar idea with the bias inverted see Béjar and Řezáč 2009).

(30) *Specifier head bias* (Assmann et al. 2012: 19)
Spec-head Agree is preferred to Agree under c-command.

- (iii) Given that subcategorization and probe features are part of a stack on a lexical item, I adopt the assumption that only the highest feature on the feature stack is visible for Agree or Merge operations at any given stage of the derivation. This condition can be formulated as part of the Earliness requirement.

(31) *Earliness* (Müller 2009: 17)

- a. An operation-inducing feature [$\bullet F \bullet$] or [$*F*$] must be checked immediately.
- b. Only the topmost operation-inducing feature ([$\bullet F \bullet$] or [$*F*$]) of a lexical item is visible.

- (iv) Following Preminger (2011) I assume that unvalued features do not lead to a crash of the derivation. Rather, features that did not get valued during the derivation are assigned a default value.

Concrete assumptions I make for A-N-N compounds:

- A subcategorizes both Ns of an A-N-N compound. Nevertheless, A can agree with only one of them.
- Subcategorization (Merge-inducing) features and Agree-inducing features on A are ordered: all Merge-inducing features have to be discharged before any Agree-inducing feature can be discharged.

In the following I present the derivation step by step.

1. A subcategorizes two Ns. First, N₁ is merged as the complement of A. Since features are ordered and all Merge-inducing features have to be discharged before Agree-inducing features, the second step is Merge of N₂ in the specifier of A.

(32)

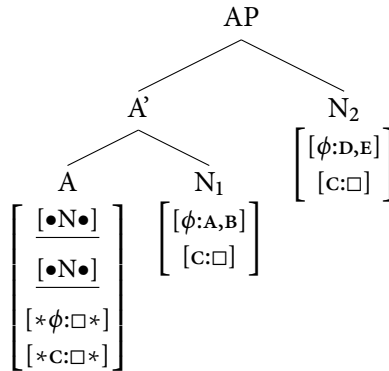

2. At this point of the derivation A could agree with N₁ in its complement or with N₂ in its specifier. Since Spec-head Agree is preferred (cf. (30)) it agrees with N₂: N₂ and A now share the valued ϕ -features of N₂. Furthermore, since neither A nor N₂ has a valued case feature they share the unvalued case feature (α).

(33)

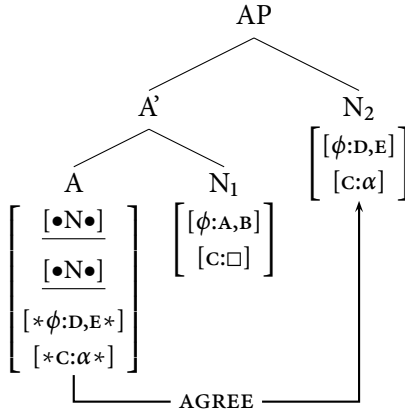

3. D is merged (D selects the AP). D bears an unvalued case-probe as well as an unvalued ϕ -probe. Agreement of D and A results in ϕ -feature-sharing of D and A as well as in sharing the unvalued case feature (α) (which is also shared by N₂).

(34)

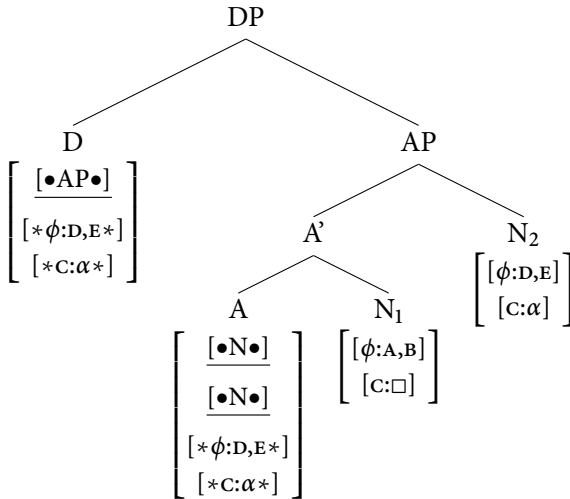

4. At some later point in the derivation v is merged. v enters an Agree relation with DP. v gets the ϕ -features of D and assigns case x to D. Since D, A, and N₂ share this unvalued case feature (α), D, A, and N₂ all are valued by little v with case x . In contrast, N₁ was never in an Agree relation with any other element at any point of the derivation (D, A or N₂). That

A ignores possible Agree with its complement N_1 and rather prefers to agree with N_2 is due to the Spec-head bias. This ‘skipping’ of N_1 leads to the same effect as to say N_1 is not accessible anymore because it already has been sent to spell-out (see 2.2 for problems with this phase-based approach): N_1 never participated in any feature-sharing process, so it is not affected by the case assignment of v . Rather, N_1 ’s case feature is valued by default as nominative case.

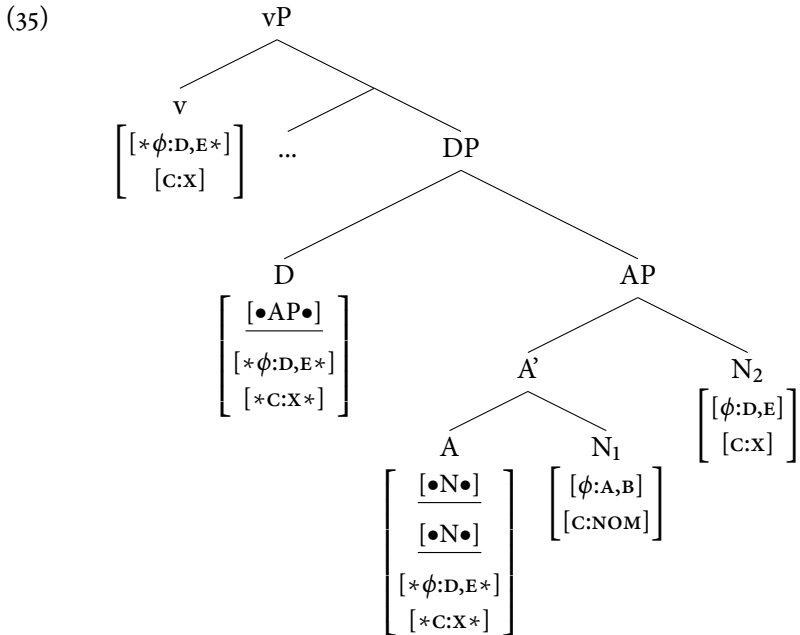

The present analysis has empirical as well as theoretical advantages. Empirically, it makes the right predictions: N_1 always bears nominative case, rather than the case which is assigned by a later element in the derivation (v , P , etc.):

- (36) a. wegen sein-es Gut-en Morgen(*s)
 because.of his-M.SG.GEN good-M.SG.GEN morning-M.SG.NOM
 Tee-s
 tea.M.SG-GEN
 ‘because of his good morning tea’

- b. aufgrund ihr-es Brav-en Mädchen(*s)
 because.of her-N.SG.GEN good-N.SG.GEN girl.N.SG.NOM
 Image-s
 image-N.SG-GEN
 'because of her good girl image'
- c. wegen d-er Rot-en Kreuz(*es)
 because.of the-F.SG.GEN red-F.SG.GEN cross.N.SG.NOM
 Schwester
 nurse.F.SG.GEN
 'because of the Red Cross nurse'

Furthermore, A and N₂ agree in number (rather than A and N₁).

- (37) a. die Schön-e Ding-e Boutique
 the nice-SG thing-PL boutique.SG
 'the boutique of nice things'
- b. *die Schön-en Ding-e Boutique
 the nice-PL thing-PL boutique.SG
 'the boutique of nice things'

From a theoretical point, the problem that DPs including an AP with only one N would have to be analyzed differently (see 2.2) is avoided. If A is merged with only one N, this N is merged as its complement. In contrast to the phase-based approach sketched in section 2.2, in the presented alternative proposal agreement between A and N is not prohibited. Since spec-head-Agree is only a bias, head-complement-Agree is still possible. If there is no specifier, head-complement-Agree applies. This is exactly the right prediction.

(38)

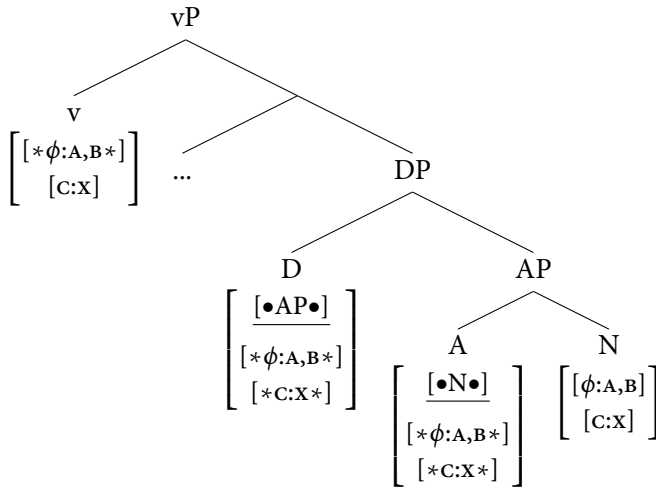

The analysis makes a further interesting prediction: Assuming the existence of A-N₁-N₂-N₃ compounds, N₂ and N₃ both should be merged in the specifier of A. Due to locality, in this case A should agree with N₂. If A-N₁-N₂-N₃ compounds really exist remains to be seen. All potential compounds which come to my mind are instances of cases where N₂ and N₃ build a compound themselves ($[_{DP} \textit{der} [_{AP} \textit{Heile Welt} [_{A'} [_{NP} [_{N} \textit{Stimmungs}]][_{N} \textit{Verbreiter}]]]]$) ‘the one who creates a perfect world feeling’, $[_{DP} \textit{die} [_{AP} \textit{Schöne Dinge} [_{A'} [_{NP} [_{N} \textit{Boutique}]][_{N} \textit{Eröffnung}]]]]$) ‘the opening of the boutique of nice things’).

3. Summary

In this paper I have shown that internal inflection in German A-N-N compounds seems to violate Earliness and locality requirements: The adjective agrees with N₂ whereas N₁ bears the unmarked case (nominative). I have argued that a classical feature-sharing analysis, as proposed for Dutch A-N-N compounds, cannot account for the German facts. This is due to the fact that German has case Agree which Dutch lacks; the feature-sharing analysis wrongly predicts that A shares the case feature with N₁, N₂ and D. Therefore, I proposed an alternative analysis which produces the correct empirical results for German. This alternative also includes feature-sharing, but the crucial point is the ordering of the elementary operations Merge and Agree on the adjective and the bias for Spec-Head-Agree due to which N₁ is skipped when

A searches for a goal for case Agree. Additionally, it can easily account for adjective-noun-agreement in regular DPs.

Concerning A-N-N compounds, there are still some unclarified issues left. Open questions are: What about the exact empirical distribution of internal agreement? If the degree of lexicalization plays a role: why does the adjective in strongly lexicalized expressions sometimes inflect and sometimes not? Do A-N₁-N₂-N₃ compounds really exist? After the discussion of some starting points in this paper, a more detailed empirical investigation is required before further conclusions can be drawn.

References

- Abney, Steven (1987): The English Noun Phrase in its sentential aspect. PhD thesis, MIT, Cambridge, MA.
- Assmann, Anke, Doreen Georgi, Fabian Heck, Gereon Müller and Philipp Weisser (2012): Ergatives Move Too Early: On an Instance of Opacity in Syntax. Ms., University of Leipzig. To appear in *Syntax*. lingbuzz/001646.
- Assmann, Anke, Svetlana Edygarova, Doreen Georgi, Timo Klein and Philipp Weisser (2014): 'Case stacking below the surface: on the possessor case alternation in Udmurt', *The Linguistic Review* 31(3-4), 447–485.
- Béjar, Susana and Milan Řezáč (2009): 'Cyclic Agree', *Linguistic Inquiry* 40, 35–73.
- Chomsky, Noam (1986): *Barriers*. MIT Press, Cambridge, Mass.
- Chomsky, Noam (1995): *The Minimalist Program*. MIT Press, Cambridge, Mass.
- Chomsky, Noam (2000): Minimalist Inquiries: the Framework. In: M. Roger, M. David and J. Uriagereka, eds, *Step by step*. MIT Press, Cambridge, Mass, pp. 89–155.
- Chomsky, Noam (2001): Derivation by Phase. In: M. Kenstowicz, ed., *Ken Hale: A Life in Language*. MIT Press, Cambridge, Mass, pp. 1–52.
- De Belder, Marijke and Marjo van Koppen (2013): The glass ceiling effect of workspaces: locality and agreement in Dutch ANN-compounds. Ms., HUBrussel, Utrecht University.
- Frampton, John and Sam Gutman (2006): How Sentences Grow in the Mind: Agreement and Selection in Efficient Minimalist Syntax. In: C. Boeckx, ed., *Agreement Systems*. Benjamins, Amsterdam, pp. 121–157.
- Georgi, Doreen and Martin Salzmann (2010): 'DP-internal double agreement is not double Agree: Consequences of Agree-based case assignment within DP', *Lingua* 121, 2069–2088.
- Heck, Fabian and Gereon Müller (2007): Extremely local optimization. In: E. Brain-

- bridge and B. Agbayani, eds, *Proceedings of the 26th WECOL*. California State University, pp. 170–183.
- Hiraiwa, Ken (2001): Multiple Agree and the Defective Intervention Constraint in Japanese. In: O. Matushansky, ed., *Proceedings of the HUMIT 2000*. University of California, Los Angeles, pp. 67–80. *Vol. 40 of UCLA Working Papers in Linguistics*.
- Koopmann, Hilda (2006): Agreement Configurations. In: C. Boeckx, ed., *Agreement Systems*. Benjamins, Amsterdam, pp. 159–201.
- Lawrenz, Birgit (1995): 'Das Graue-Maus-Dasein und das Brave-Mädchen-Image: Zur Bildungsweise von A-N-N-Komposita im Deutschen', *Deutsch als Fremdsprache* 32(1), 39–42.
- Müller, Gereon (2009): Ergativity, Accusativity and the Order of Merge and Agree. In: K. Grohmann, ed., *Explorations of Phase Theory. Features and Arguments*. Mouton de Gruyter, pp. 269–308.
- Pesetsky, David (1989): Language-particular Processes and the Earliness Principle. Ms., MIT.
- Pesetsky, David and Esther Torrego (2007): The Syntax of valuation and the interpretability of features. In: S. Karimi, V. Samiian and W. Wilkins, eds, *Phrasal and clausal architecture. Syntactic derivation and interpretation*. John Benjamins, Amsterdam, pp. 262–294.
- Preminger, Omer (2011): Agreement as a Fallible Operation. PhD thesis, MIT, Cambridge, Mass.
- Schoorlemmer, Erik (2009): Agreement, Dominance and Doubling. The morphosyntax of DP. PhD thesis, LOT, Utrecht.
- Svenonius, Peter (1994): The structural location of the attributive adjective. In: E. Duncan, ed., *Proceedings of the 12th WCCFL*. CSLI Publications, pp. 439–454.
- Vainikka, Anne and Pauli Brattico (2014): 'The Finnish Accusative: Long-distance case assignment under agreement', *Linguistics* 52(1), 73–124.

